

Adventure Trails

The logo for Reids Playground Maintenance Ltd, featuring the letters 'R', 'P', and 'W' in a stylized, overlapping font. The 'R' is purple, the 'P' is red, and the 'W' is green.

REIDS PLAYGROUND MAINTENANCE LTD

Balance Walk

L 2400 W 125 H 433mm
FFH 433mm

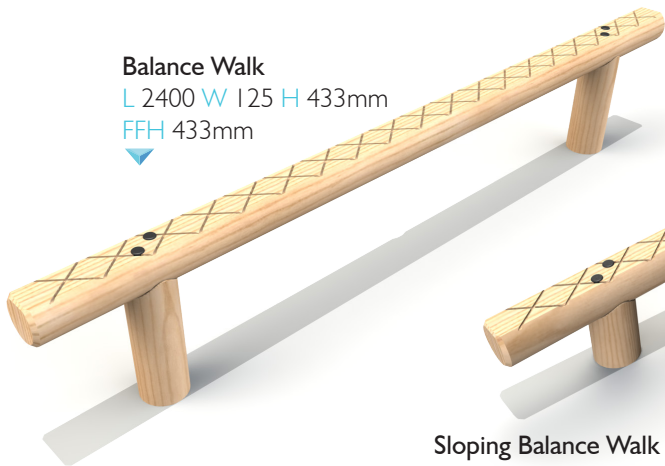

Sloping Balance Walk

L 2400 W 125 H 434mm
FFH 434mm

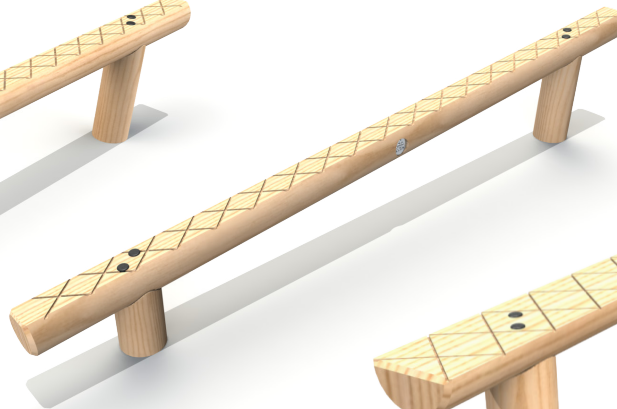

Balance Beam

L 2400 W 200 H 435mm
FFH 435mm

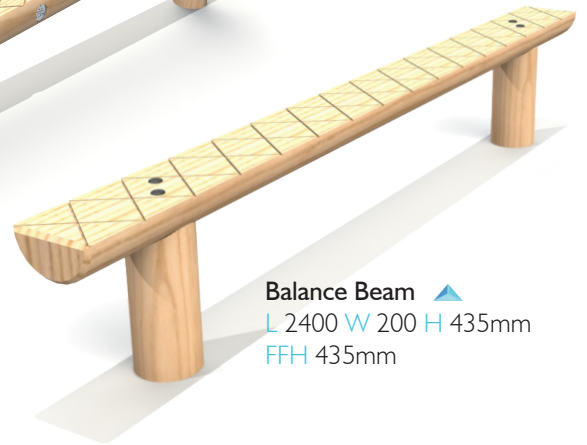

Balance Junction

L 2400 W 2400 H 550mm
FFH 550mm

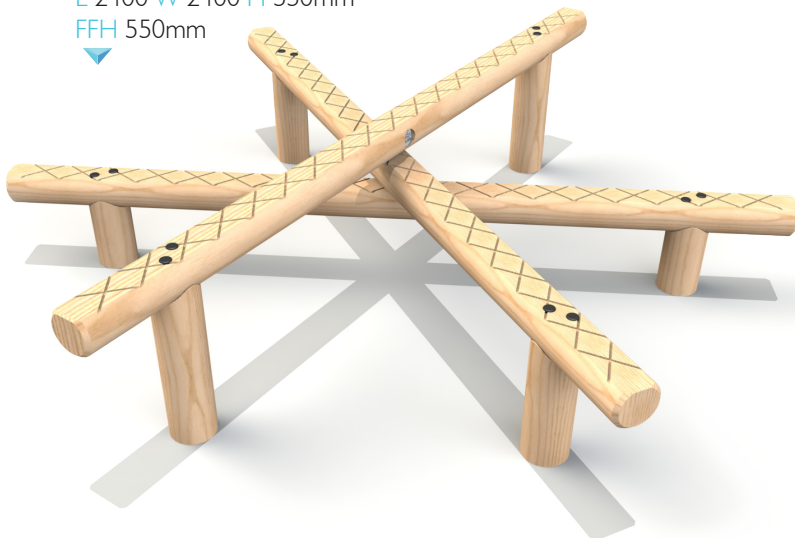

V Balance Beam

L 2002 W 2050 H 470mm
FFH 470mm

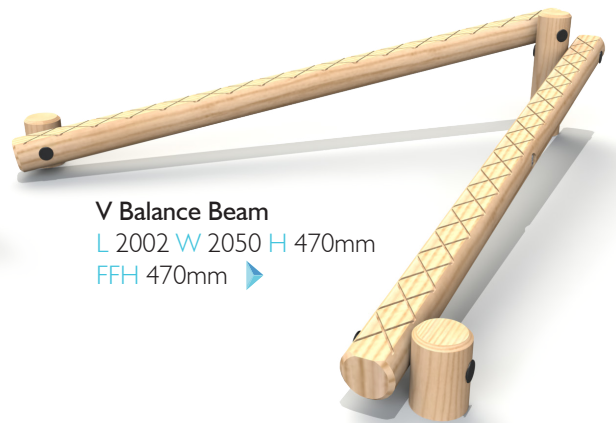

Balance Challenge

L 6900 W 1600 H 434mm
FFH 434mm

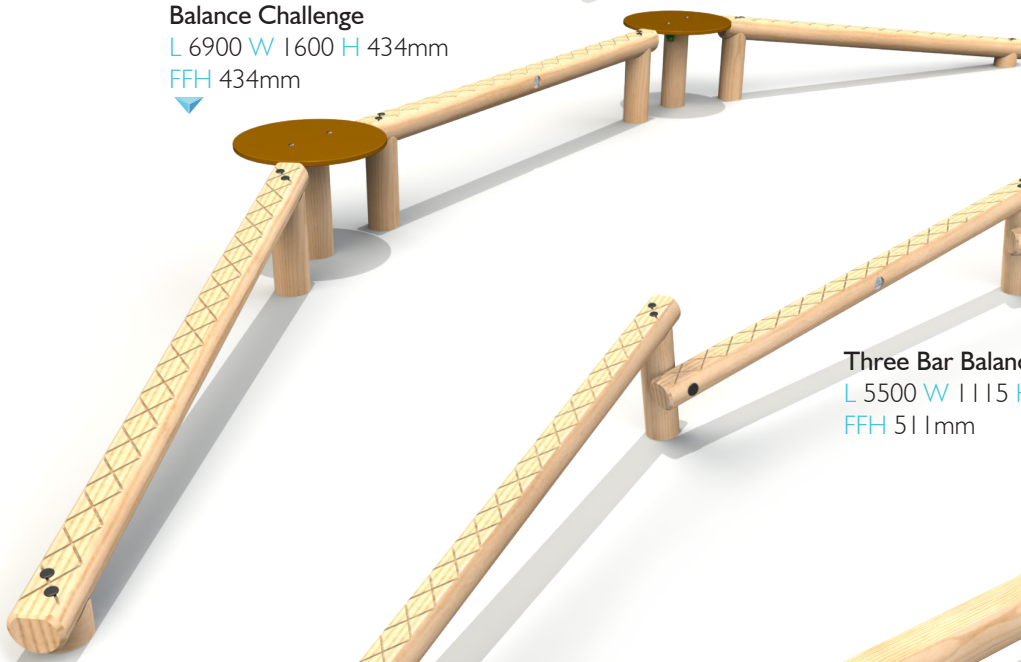

Three Bar Balance

L 5500 W 1115 H 511mm
FFH 511mm



Low Log Roll

L 3300 W 200 H 500mm
FFH 500mm





Balance Slalom
L 3250 W 1200 H 585mm
FFH 585mm

Sloping Balance Weave
L 2792 W 375 H 1800mm
FFH 555mm

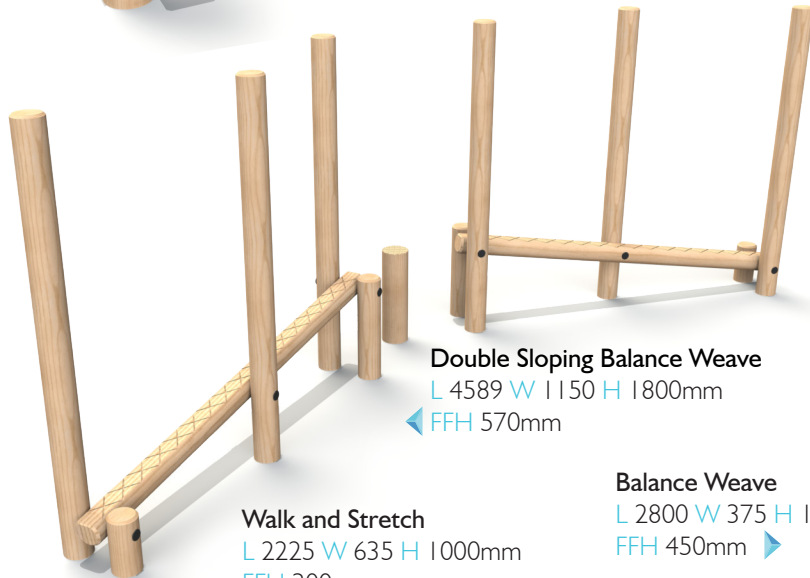

Double Sloping Balance Weave
L 4589 W 1150 H 1800mm
FFH 570mm

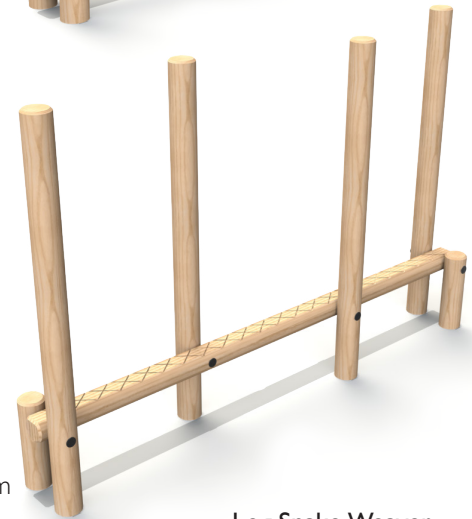

Balance Weave
L 2800 W 375 H 1800mm
FFH 450mm

Walk and Stretch
L 2225 W 635 H 1000mm
FFH 300mm

Log Snake Weaver
L 1790 W 661 H 1500mm
FFH 300mm

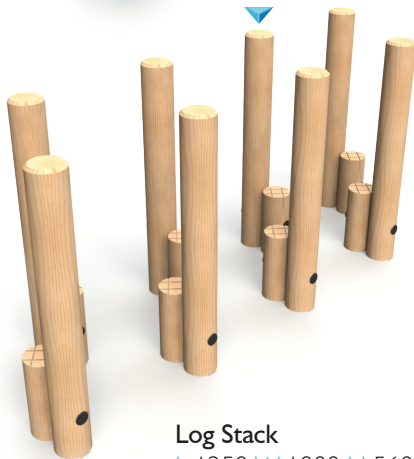

Log Stack
L 1250 W 1800 H 560mm
FFH 560mm



Log Snake
L 1565 W 410 H 500mm
FFH 500mm

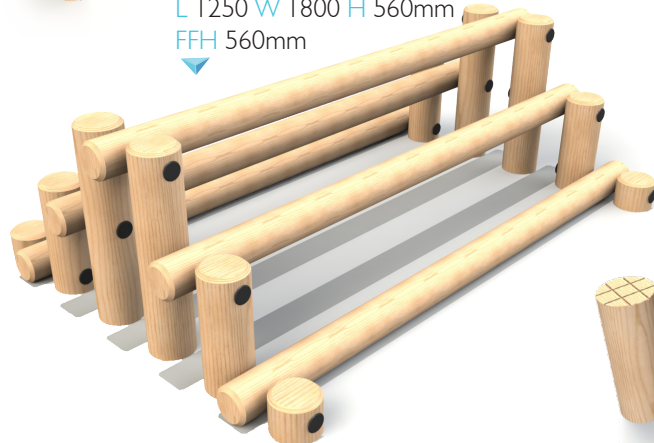
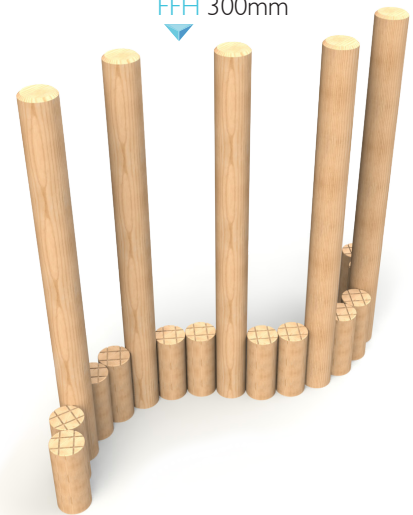

150mm Stepping Logs (set of 4)
L 400 W 150 H 400mm
FFH 400mm

200mm Stepping Logs (set of 4)
L 400 W 200 H 400mm
FFH 400mm

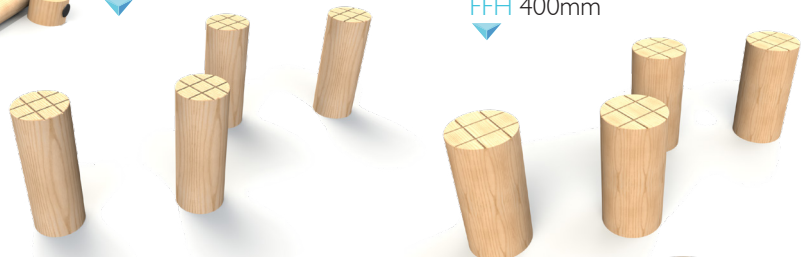

Steel feet

Galvanised steel feet can be fitted on all Timber Trails for a small additional charge. Steel feet offer an alternative to in-ground timbers and can be used in both wet pour and extended for loose fill surfacing.



600mm Wobble Board
L 600 W 195 H 380mm
FFH 600mm ▶

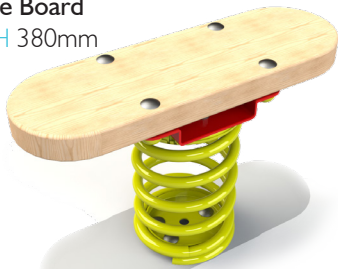

1.6m Wobble Board
L 1600 W 195 H 380mm
FFH 600mm ▼

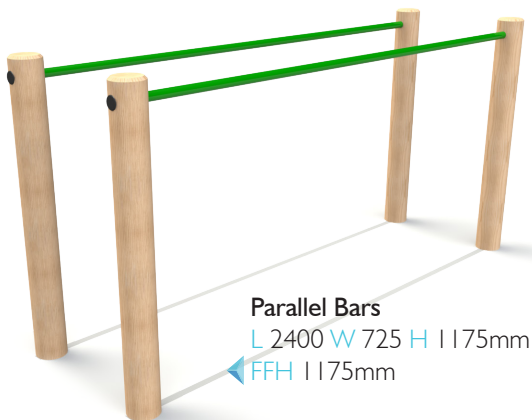
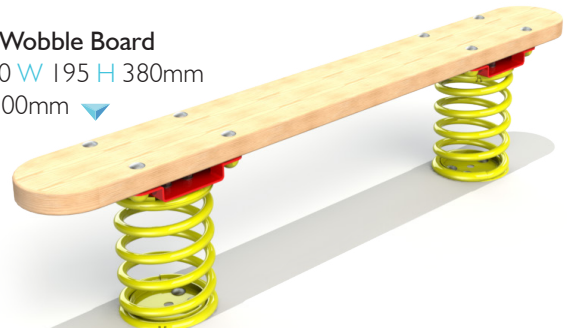

Parallel Bars
L 2400 W 725 H 1175mm
◀ FFH 1175mm

Tightrope Crossing
L 4695 W 850 H 1200mm
▼ FFH 400mm

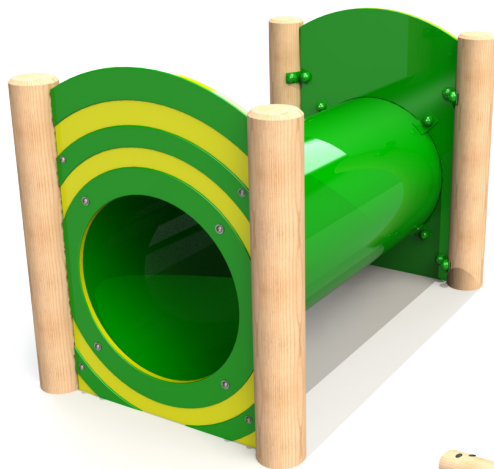
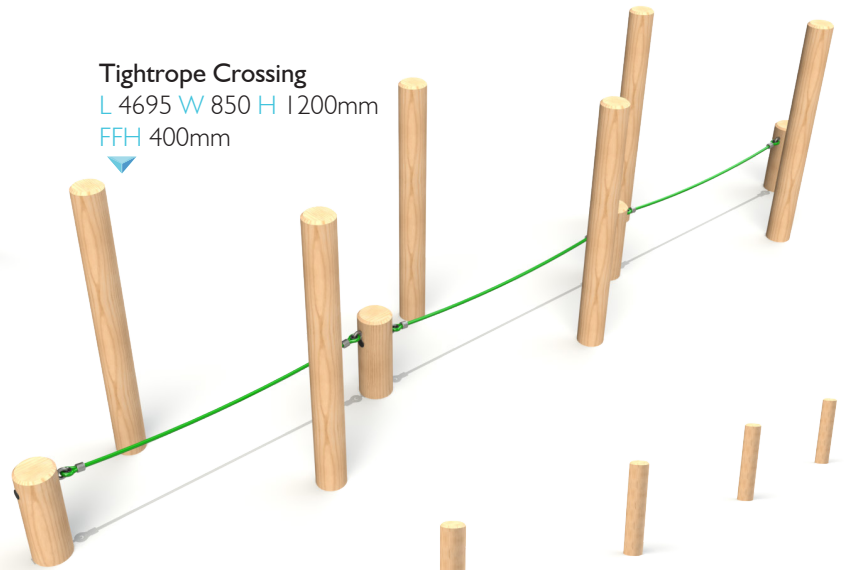

Free Standing Tunnel ▲
L 1338 W 850 H 965mm
FFH 135mm

Leap Frog ▶
L 9125 W 125 H 600mm
FFH 600mm

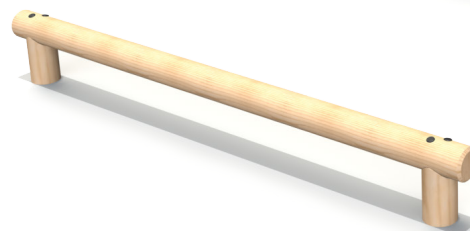
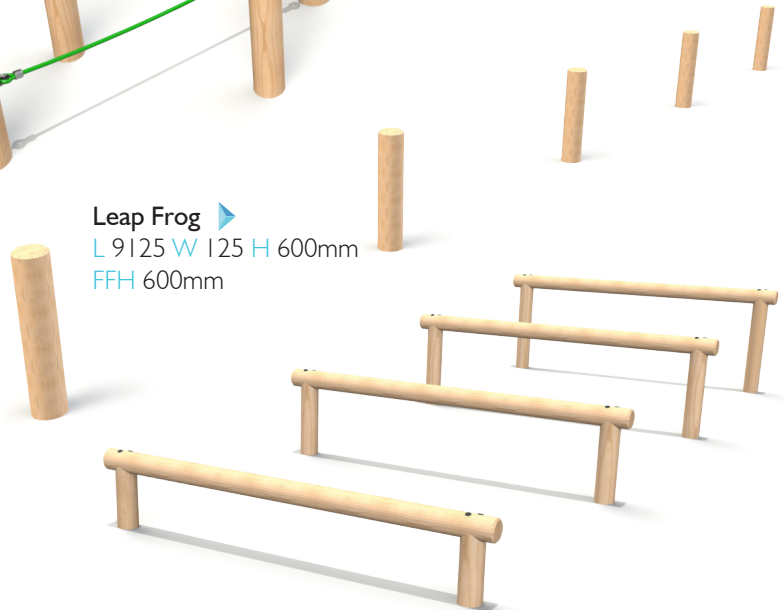

Log Hurdles ▲
L 8125 W 2400 H 903mm
FFH 903mm

Roll Over Bars
L 3200 W 125 H 1100mm
▼ FFH 1100mm

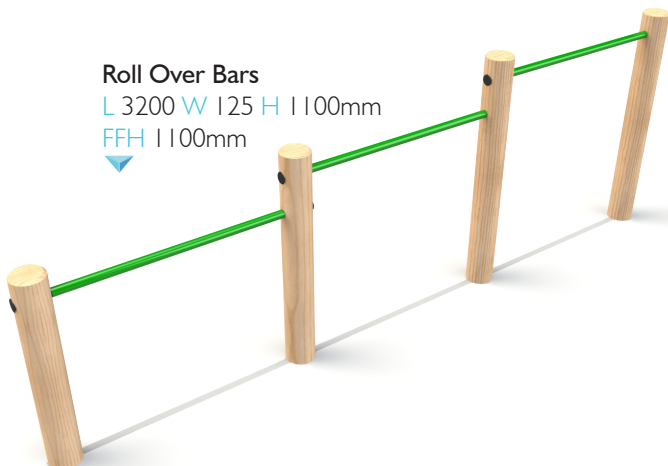

1.5m Chin Ups ▲
L 3200 W 125 H 1500mm
FFH 1500mm

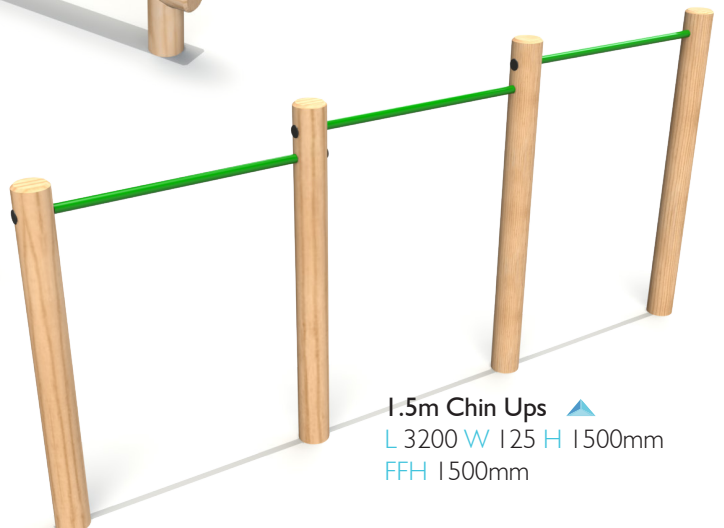

Crawl Net

L 2107 W 1179 H 599mm
FFH 599mm ▼

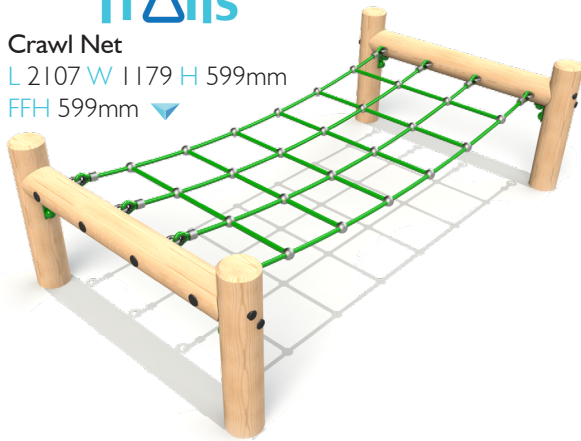

Spider Web Net

L 3243 W 3243 H 1500mm
FFH 459mm ▼

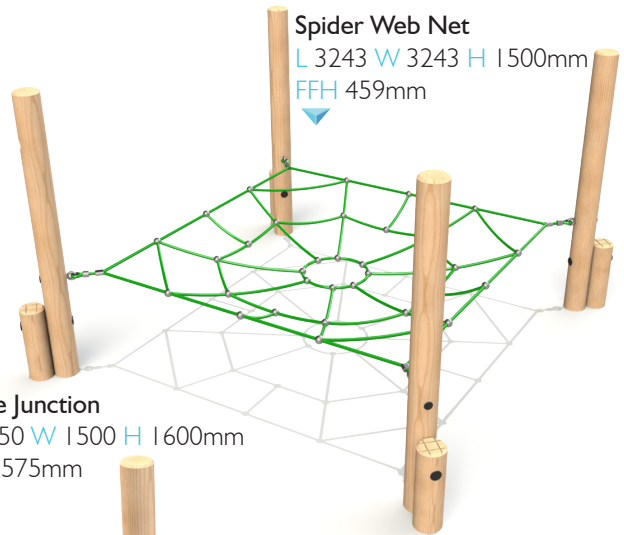

Rope Junction

L 2850 W 1500 H 1600mm
FFH 575mm ▼

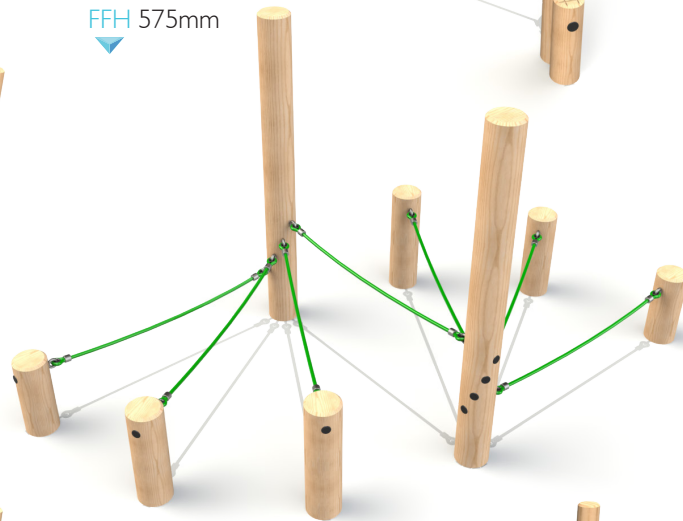

Wobble Log Bridge

L 2700 W 1200 H 1700mm
FFH 536mm ▼

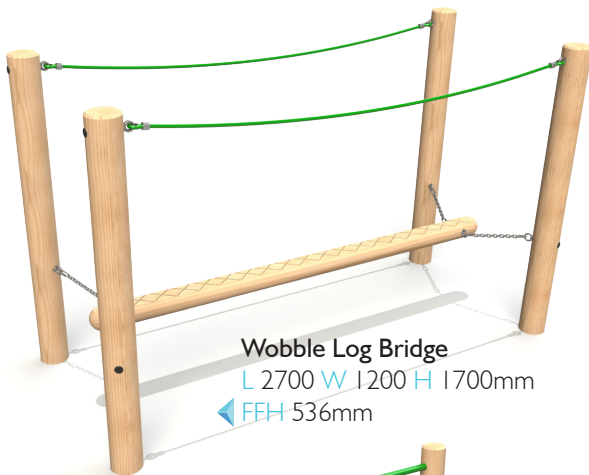

Rope Crossing

L 2650 W 1000 H 1400mm
FFH 450mm ▼

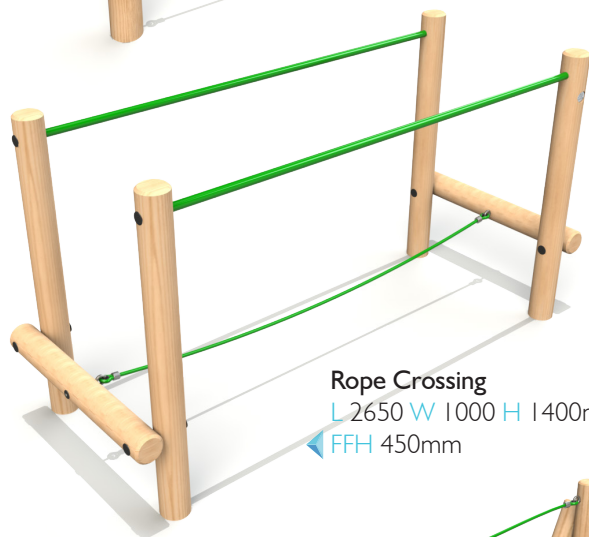

Wobble Bridge

L 2700 W 1200 H 1400mm
FFH 513mm ▼

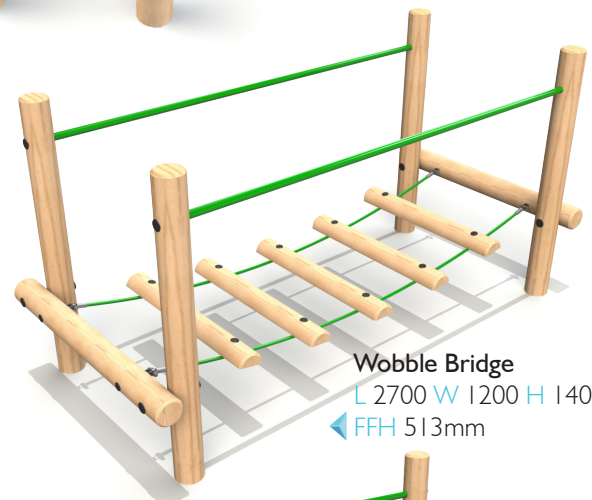

Burma Bridge

L 3000 W 1125 H 1450mm
FFH 523mm ▲

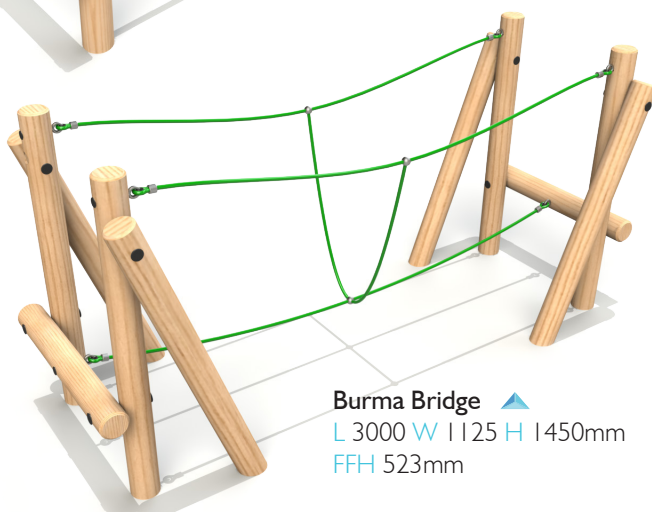

Suspension Bridge

L 2225 W 1300 H 1400mm
FFH 513mm ▼

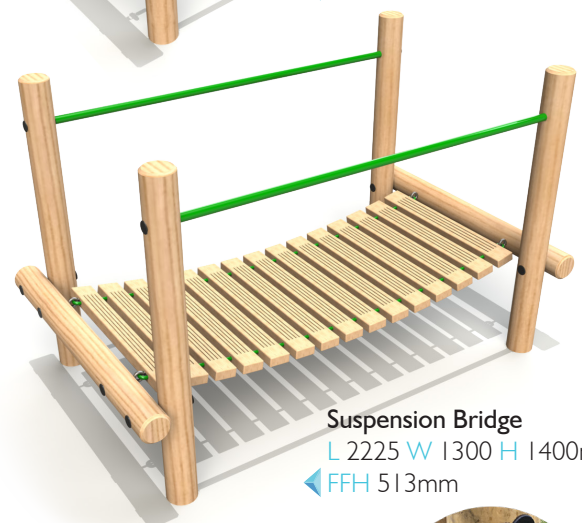

Steel feet

Galvanised steel feet can be fitted on all Timber Trails for a small additional charge. Steel feet offer an alternative to in-ground timbers and can be used in both wet pour and extended for loose fill surfacing.



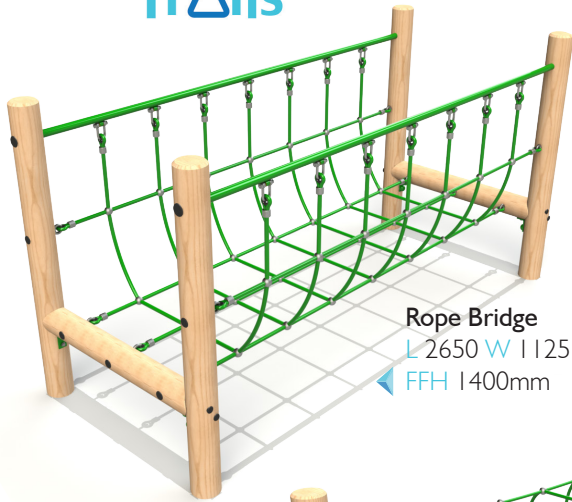

Rope Bridge
L 2650 W 1125 H 1400mm
FFH 1400mm

Underground Tunnel

L 1925 W 1450 H 1200mm
FFH Dependant on mound

Mound not included.

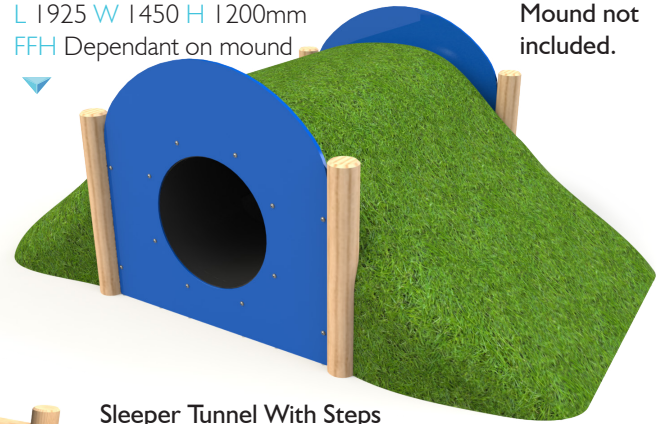

Rope Tunnel

L 2700 W 1000 H 1425mm
FFH 1425mm

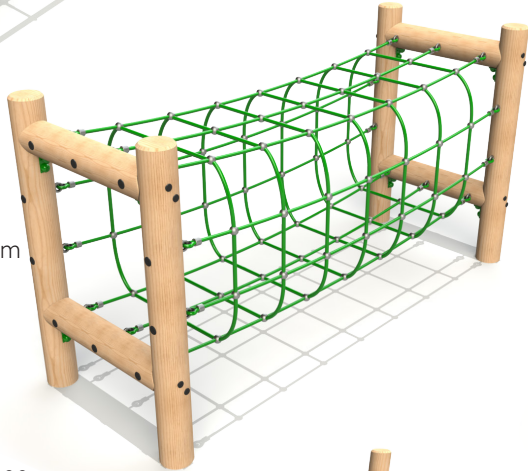

Sleeper Tunnel With Steps

L 2400 W 1390 H 1700mm
FFH 859mm

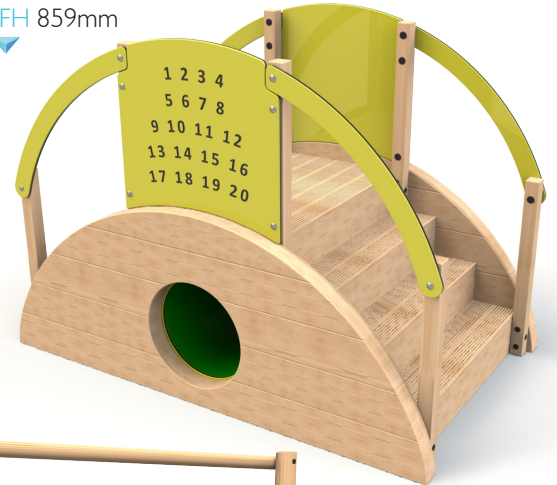

Slalom Rope Walk

L 4322 W 695 H 1800mm
FFH 458mm

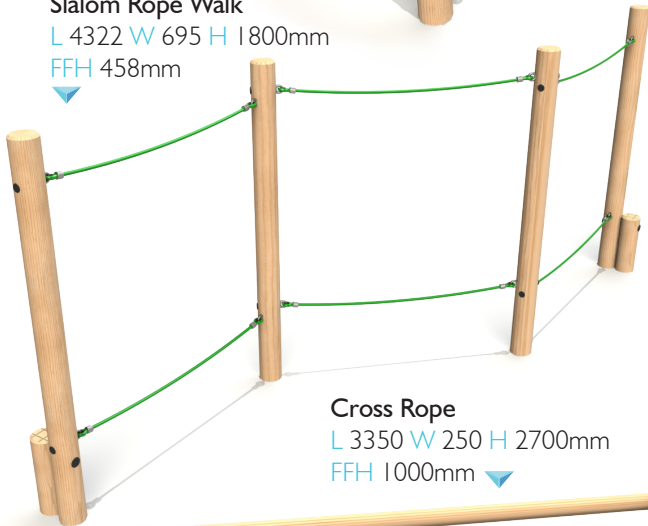

Cross Rope

L 3350 W 250 H 2700mm
FFH 1000mm



Rope Walk

L 3350 W 250 H 2700mm
FFH 460mm

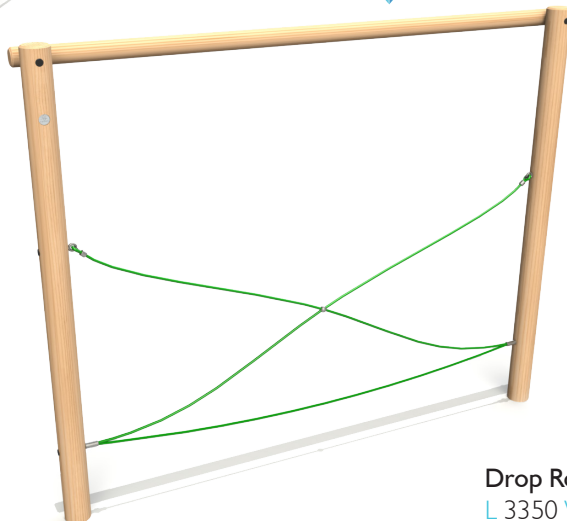

Drop Rope Traverse

L 3350 W 300 H 2500mm
FFH 521mm

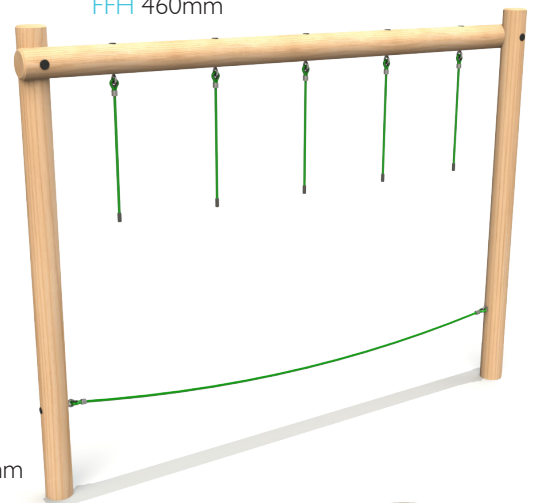

Steel feet

Galvanised steel feet can be fitted on all Timber Trails for a small additional charge. Steel feet offer an alternative to in-ground timbers and can be used in both wet pour and extended for loose fill surfacing.



Tarzan Traverse

L 3350 W 300 H 2700mm
FFH 520mm ▼

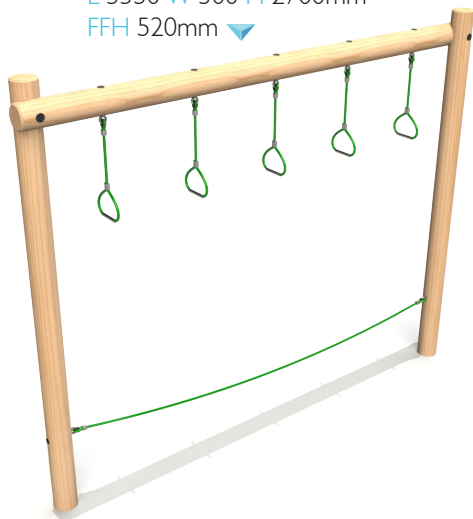

Log Rope

L 3000 W 450 H 2575mm
FFH 436mm ▼

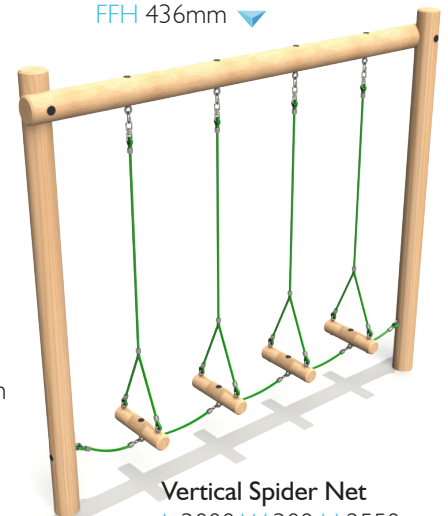

Log Roll ▲

L 3350 W 250 H 2700mm
FFH 462mm

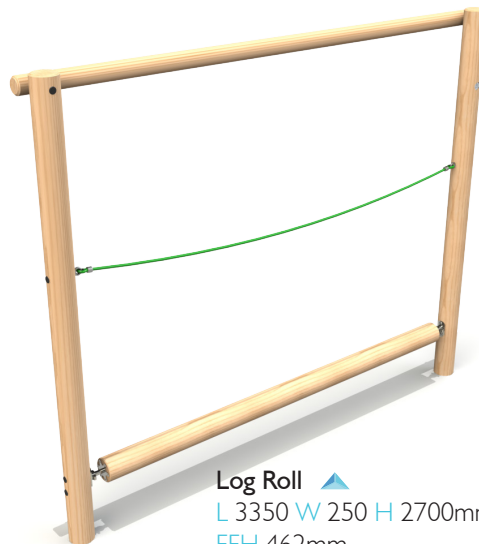

Vertical Spider Net

L 3000 W 300 H 2550mm
FFH 2550mm ▼

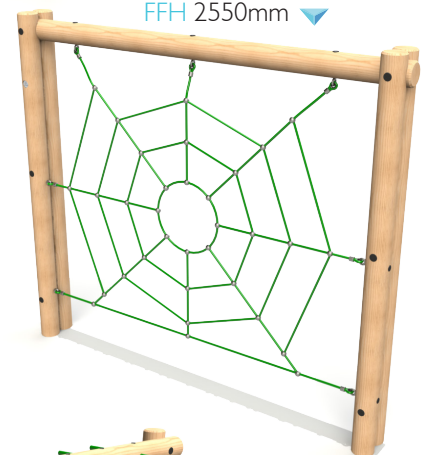

Log Roll with Drop Ropes

L 3350 W 225 H 2500mm
FFH 462mm ▼

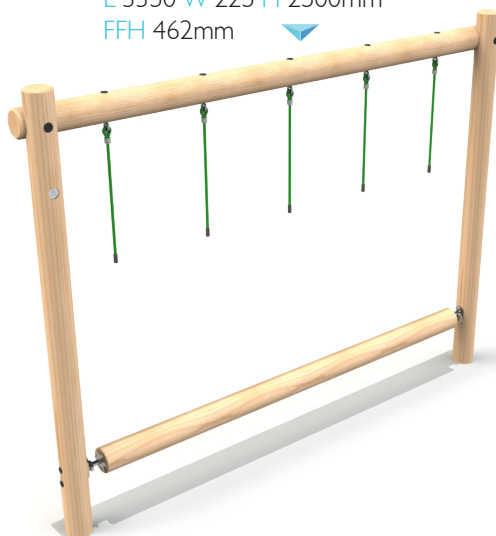

Rope Weave ▲

L 3350 W 300 H 2700mm
FFH 520mm

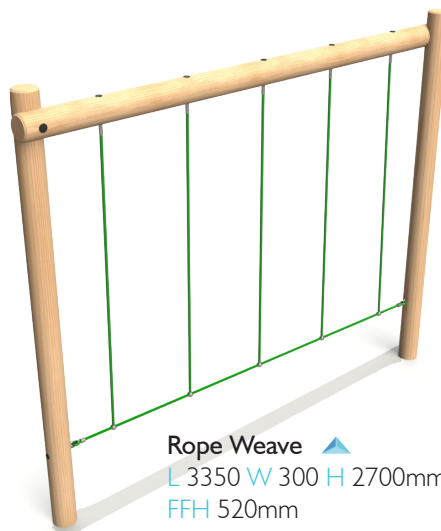

Monkey Bars

L 2862 W 1110 H 1850mm
FFH 1850mm ▼

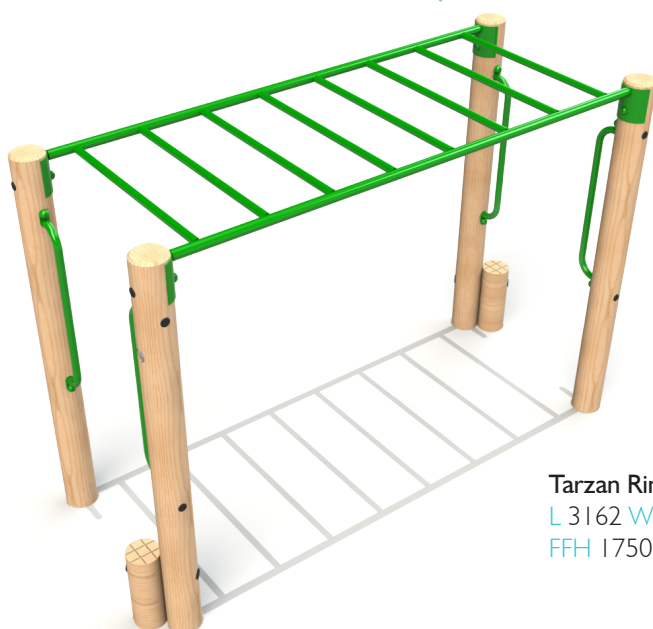

Monkey Bar Log

L 3450 W 720 H 2085mm
FFH 1975mm ▼

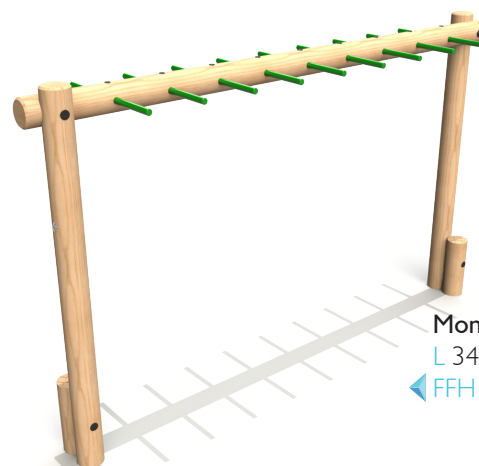

Tarzan Ring Beam ▶

L 3162 W 1110 H 2050mm
FFH 1750mm

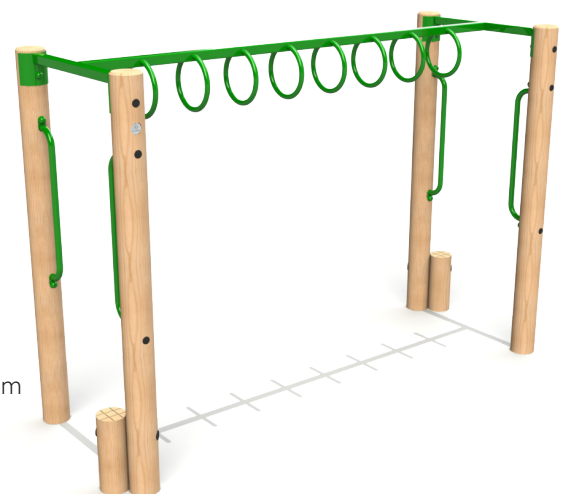

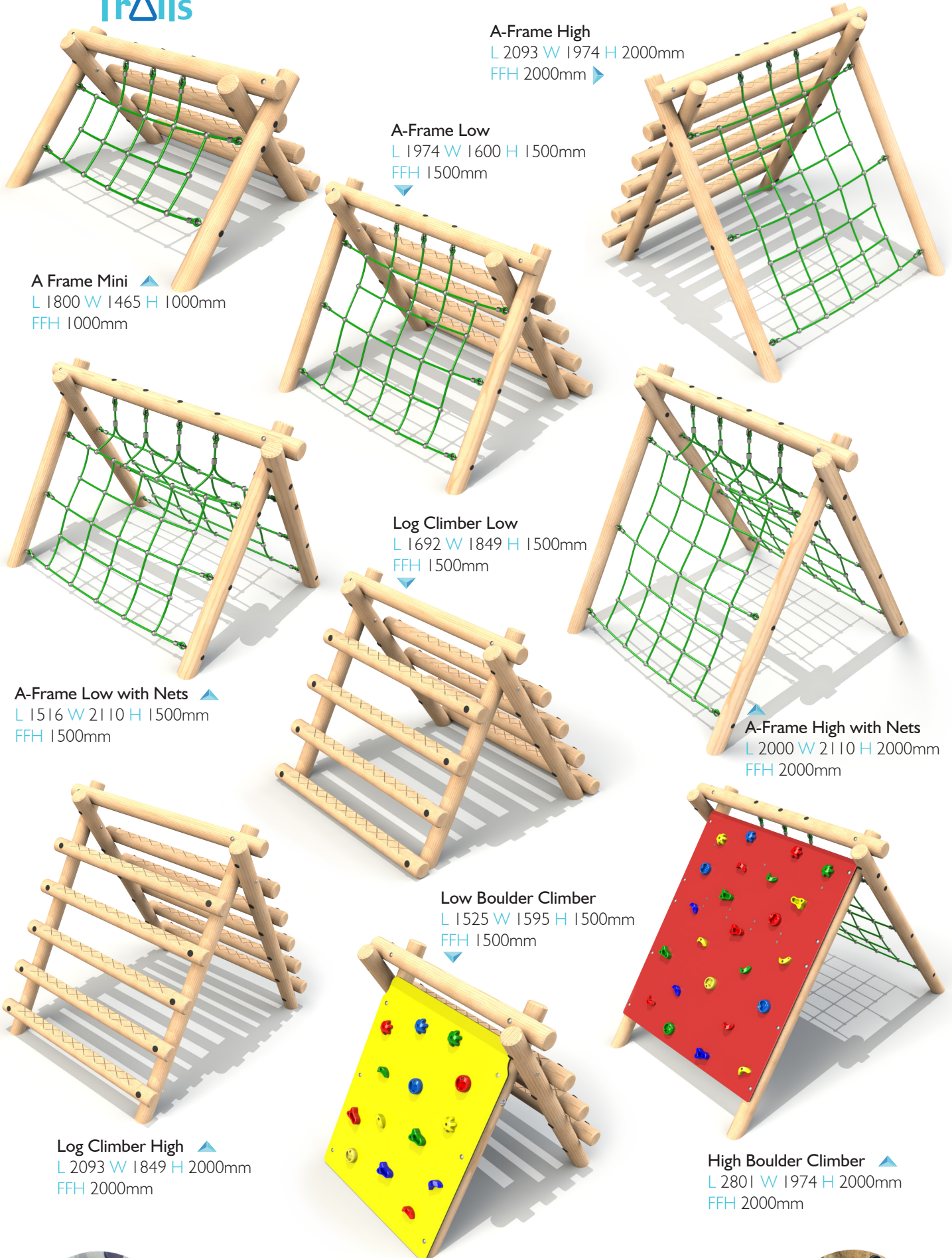

A-Frame High
L 2093 W 1974 H 2000mm
FFH 2000mm ▶

A-Frame Low
L 1974 W 1600 H 1500mm
FFH 1500mm ▼

A Frame Mini ▲
L 1800 W 1465 H 1000mm
FFH 1000mm

Log Climber Low
L 1692 W 1849 H 1500mm
FFH 1500mm ▼

A-Frame Low with Nets ▲
L 1516 W 2110 H 1500mm
FFH 1500mm

A-Frame High with Nets
L 2000 W 2110 H 2000mm
FFH 2000mm

Low Boulder Climber
L 1525 W 1595 H 1500mm
FFH 1500mm ▼

Log Climber High ▲
L 2093 W 1849 H 2000mm
FFH 2000mm

High Boulder Climber ▲
L 2801 W 1974 H 2000mm
FFH 2000mm



Steel feet

Galvanised steel feet can be fitted on all Timber Trails for a small additional charge. Steel feet offer an alternative to in-ground timbers and can be used in both wet pour and extended for loose fill surfacing.



Timber Trails

Dimensions do not include surfacing
FFH - Free Fall Height

Climb Net
L 150 W 2060 H 1500mm
FFH 1500mm

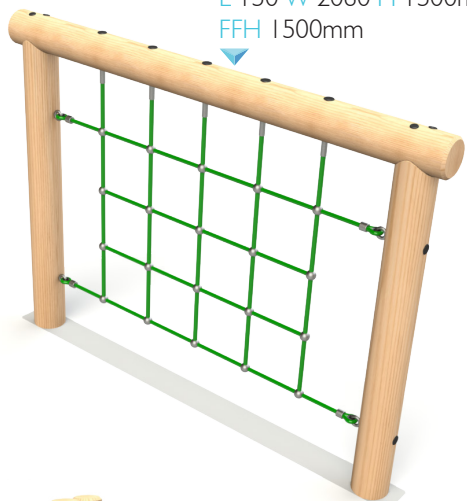

Mini Twist Net
L 2632 W 1100 H 1500mm
FFH 1500mm

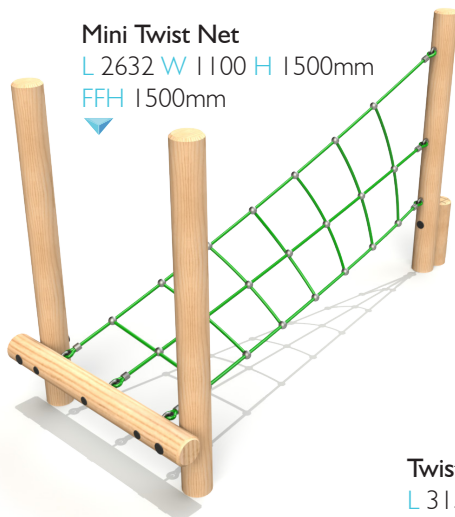

Climb Ladder
L 150 W 1350 H 1730mm
FFH 1730mm



Twist Net
L 3150 W 2295 H 1900mm
FFH 1900mm

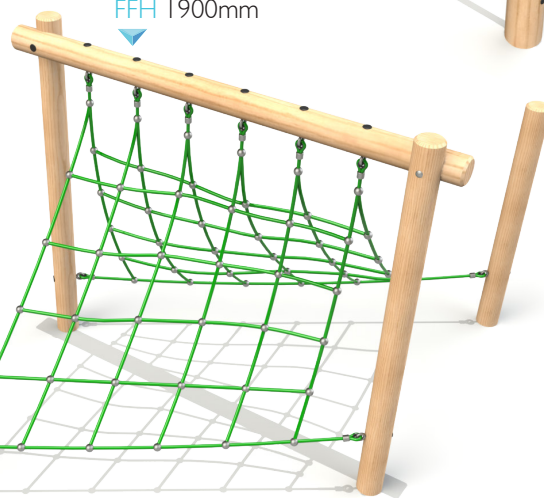

Timber Gate Climber
L 1900 W 312 H 1900mm
FFH 1900mm

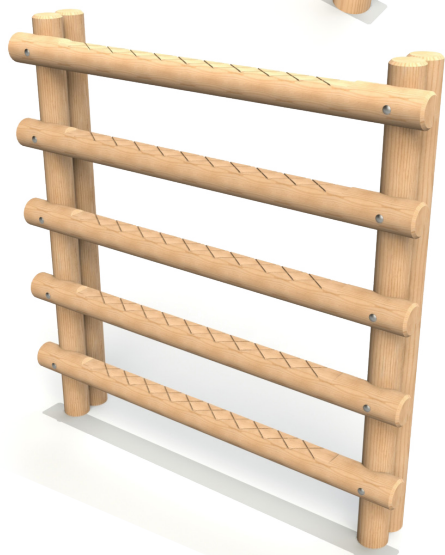

Wall Net Combo
L 6770 W 150 H 2380mm
FFH 1139mm (Double Sided)



Traverse Wall
L 2850 W 150 H 1800mm
FFH 500mm (Double Sided)

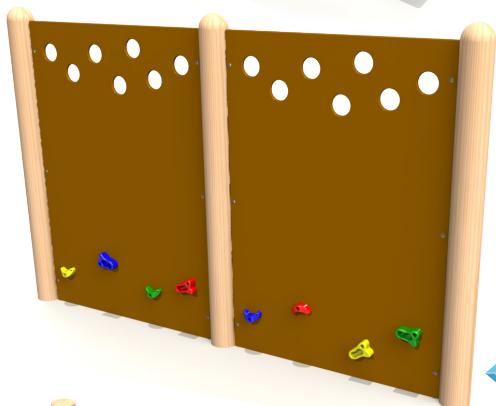

Jigsaw Traverse Wall
L 2670 W 825 H 1850mm
FFH 599mm

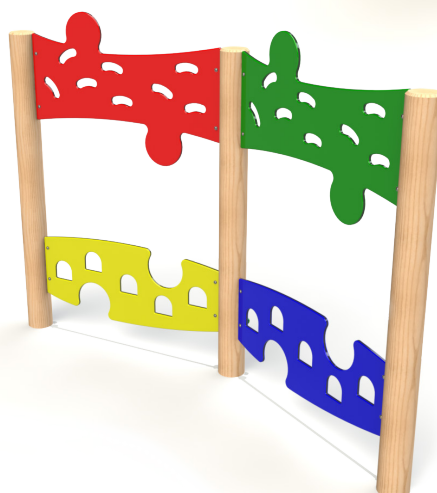

Traverse Weave Combo
L 2764 W 802 H 2100mm
FFH 599mm (Double Sided)



Zig Zag Traverse Wall
L 3922 W 840 H 1800mm
FFH 599mm

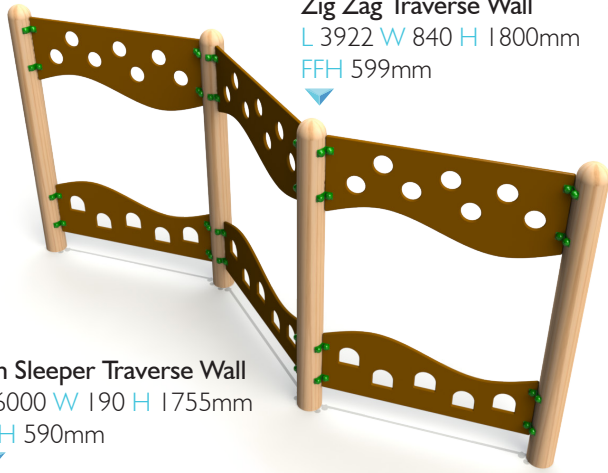

Sleeper Climb Wall
L 4000 W 385 H 2340mm
FFH 2340mm (Double Sided)



6m Sleeper Traverse Wall
L 6000 W 190 H 1755mm
FFH 590mm

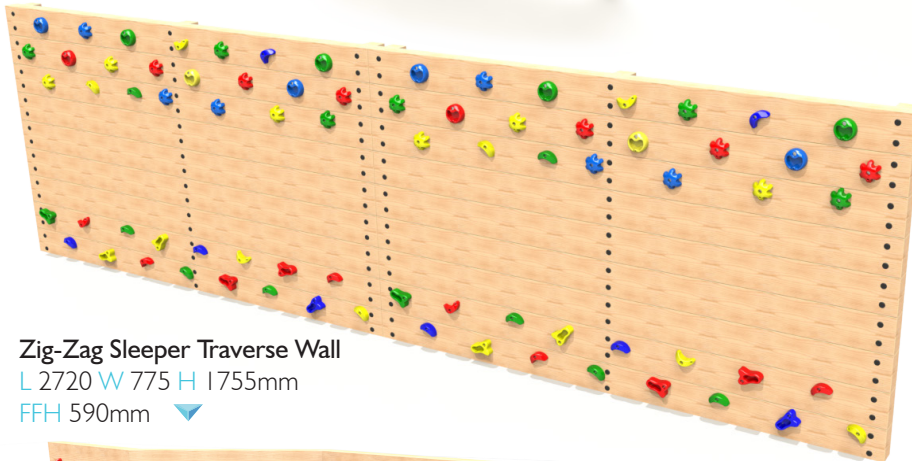

Embankment Ramp
L 2196 W 1350 H 1300mm
FFH 275mm

FFH is assuming the ramp is situated on a bank with no drops.

Recommended angle for embankment is 30 degrees.

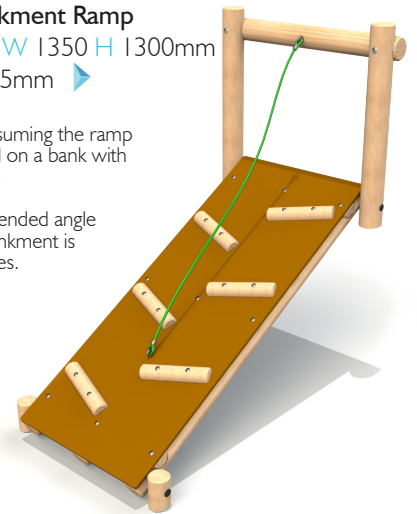

Zig-Zag Sleeper Traverse Wall
L 2720 W 775 H 1755mm
FFH 590mm

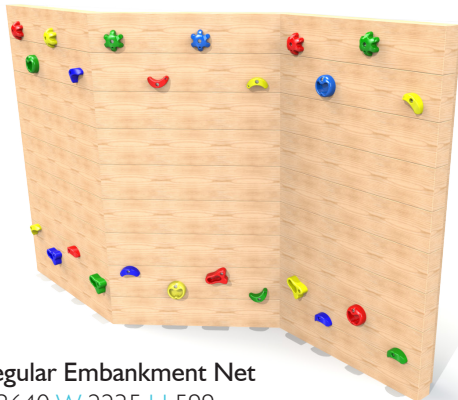

Medium Embankment Net
L 4305 W 2475 H 599mm
FFH 599mm

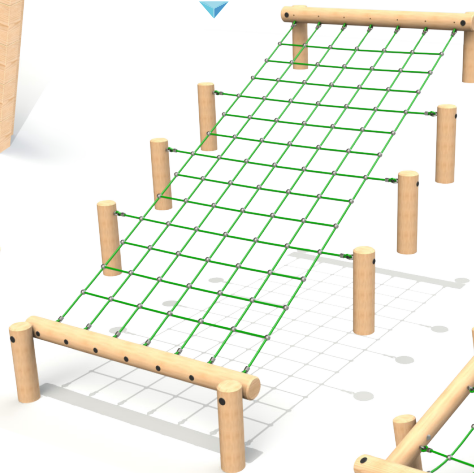

Regular Embankment Net
L 3640 W 2235 H 599mm
FFH 599mm

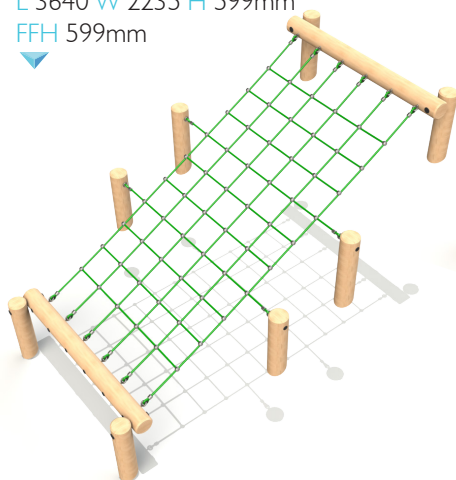

Large Embankment Net
L 5050 W 2800 H 825mm
FFH 825mm

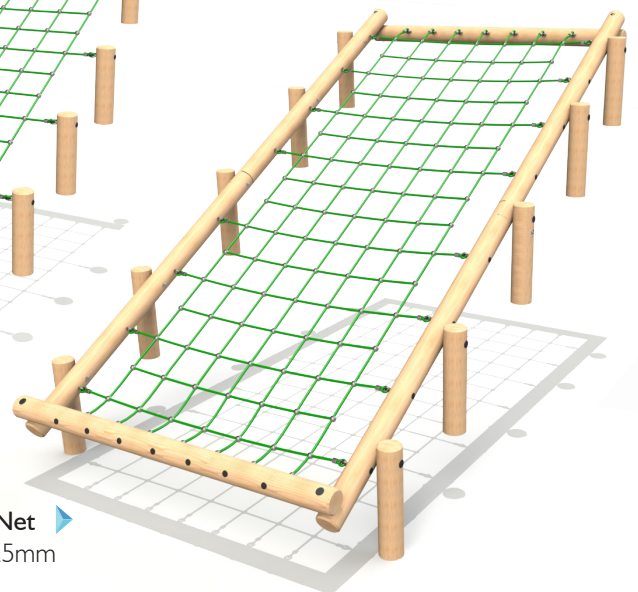

Steel feet

Galvanised steel feet can be fitted on all Timber Trails for a small additional charge. Steel feet offer an alternative to in-ground timbers and can be used in both wet pour and extended for loose fill surfacing.



Trail 1

L=21m W=1.6m Not including Safety Surface

Consists of: *Sloping Balance Walk, Balance Walk, Drop Rope Traverse, 200mm Stepping Logs, Sloping Balance Weave, Balance Challenge.*



Trail 2

L=21m W=0.64m Not including Safety Surface

Consists of: *Sloping Balance Walk, Cross Rope, 200mm Stepping Logs, Log Rope, Log Snake, Rope Walk, Walk and Stretch, Sloping Balance Walk.*



Trail 3

L=20m W=1.3m Not including Safety Surface

Consists of: *Sloping Balance Walk, Suspension Bridge, Log Snake, Log Roll, 200mm Stepping Logs, Burma Bridge, Sloping Balance Walk, Log Snake Weaver.*

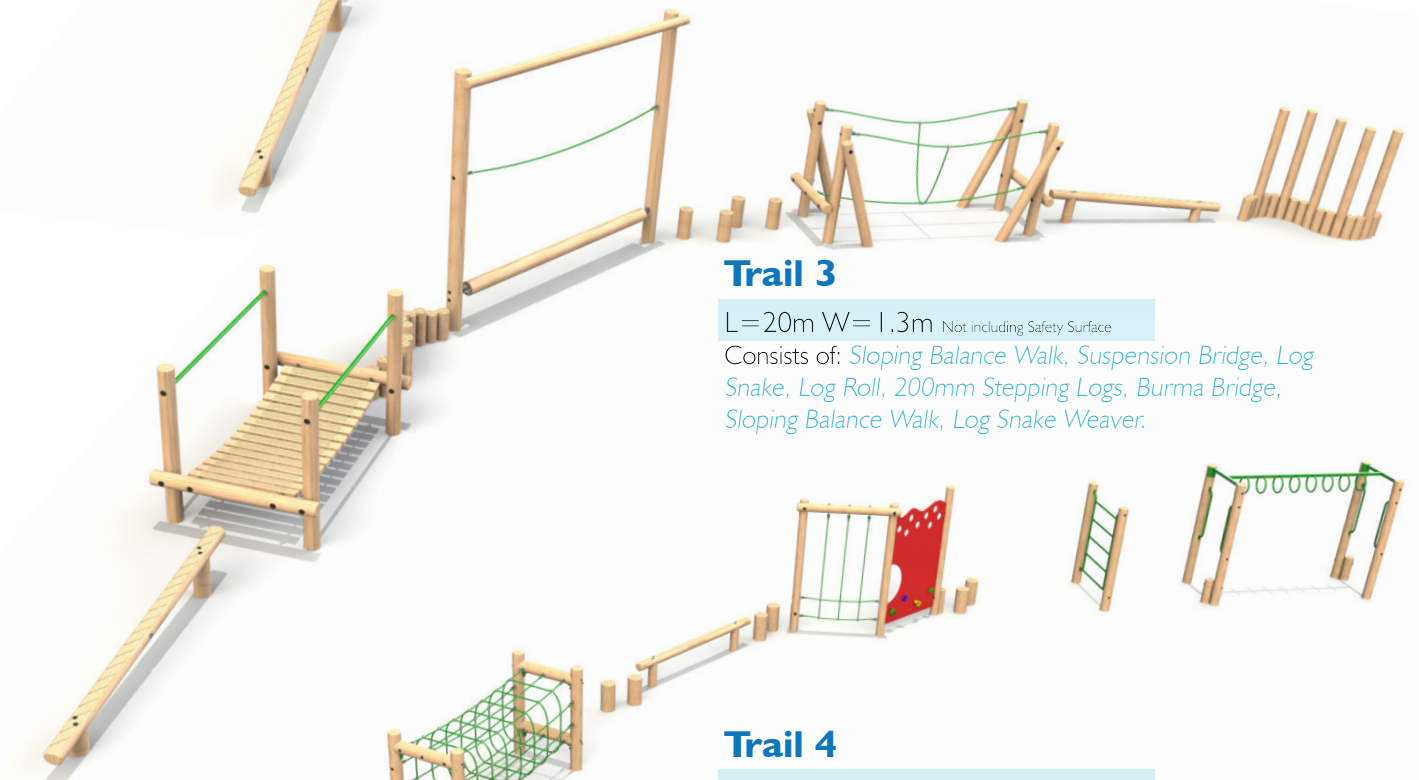

Trail 4

L=25.5m W=1.1m Not including Safety Surface

Consists of: *Tightrope Crossing, Rope Tunnel, 200mm Stepping Logs, Balance Walk, Traverse Weave Combo, Climb Ladder, Tarzan Ring Beam.*



All trails can be arranged differently to suit your needs.

Trail 5

L=17.5m W=1.2m Not including Safety Surface

Consists of: 200mm Stepping Logs, Crawl Net, Slalom Rope Walk, Rope Weave, 1.6m Wobble Board, Balance Slalom.

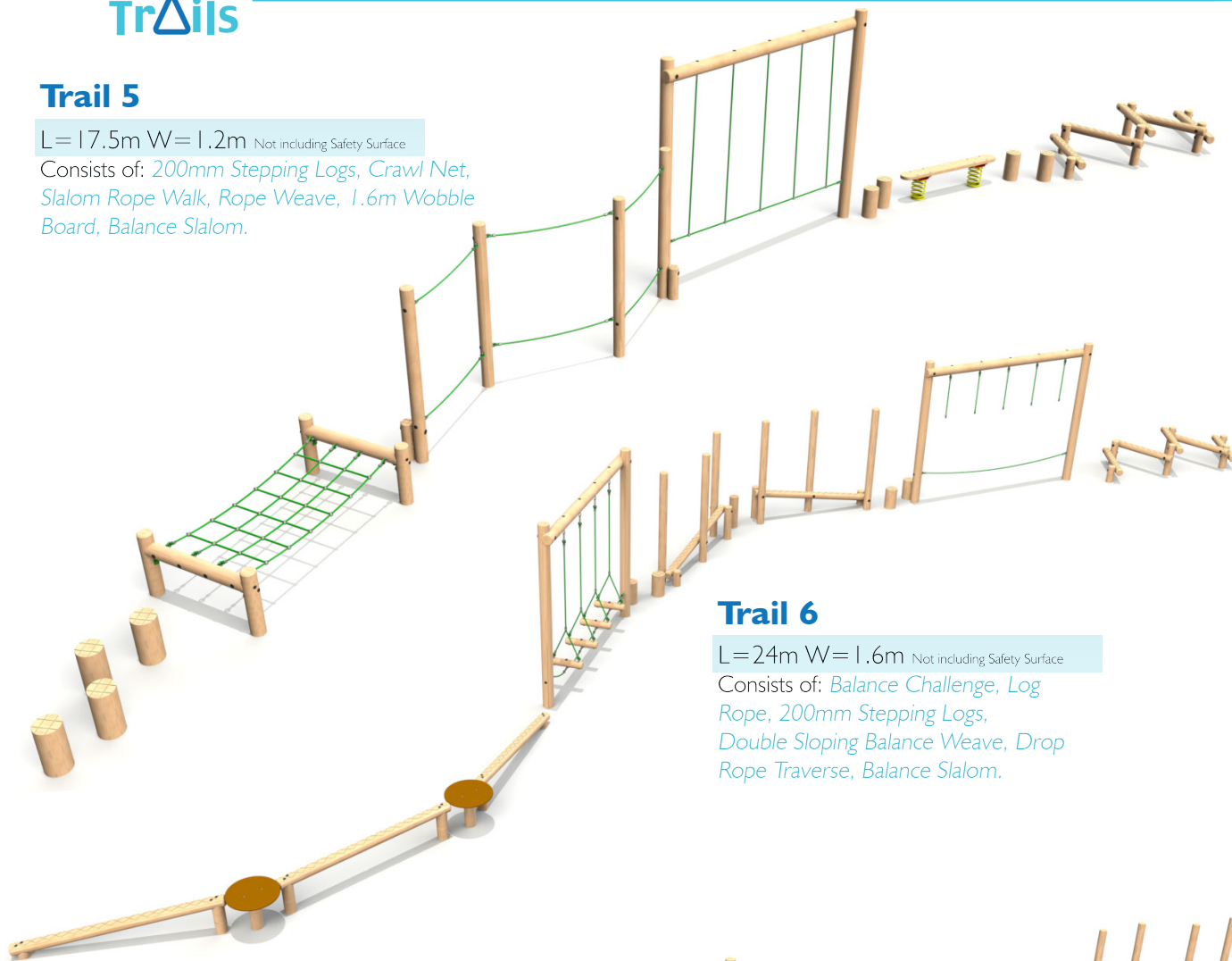

Trail 6

L=24m W=1.6m Not including Safety Surface

Consists of: Balance Challenge, Log Rope, 200mm Stepping Logs, Double Sloping Balance Weave, Drop Rope Traverse, Balance Slalom.

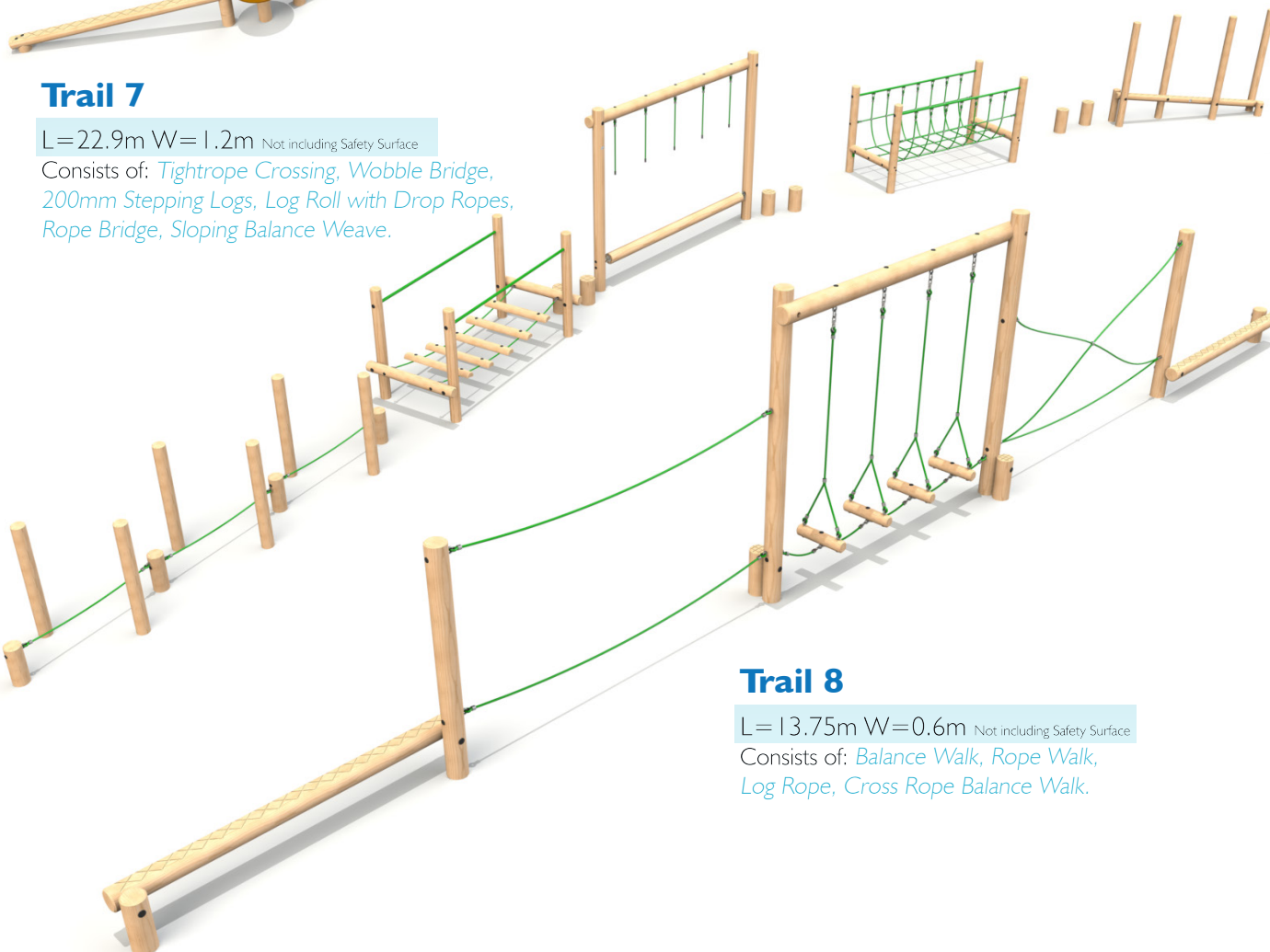

Trail 7

L=22.9m W=1.2m Not including Safety Surface

Consists of: Tightrope Crossing, Wobble Bridge, 200mm Stepping Logs, Log Roll with Drop Ropes, Rope Bridge, Sloping Balance Weave.

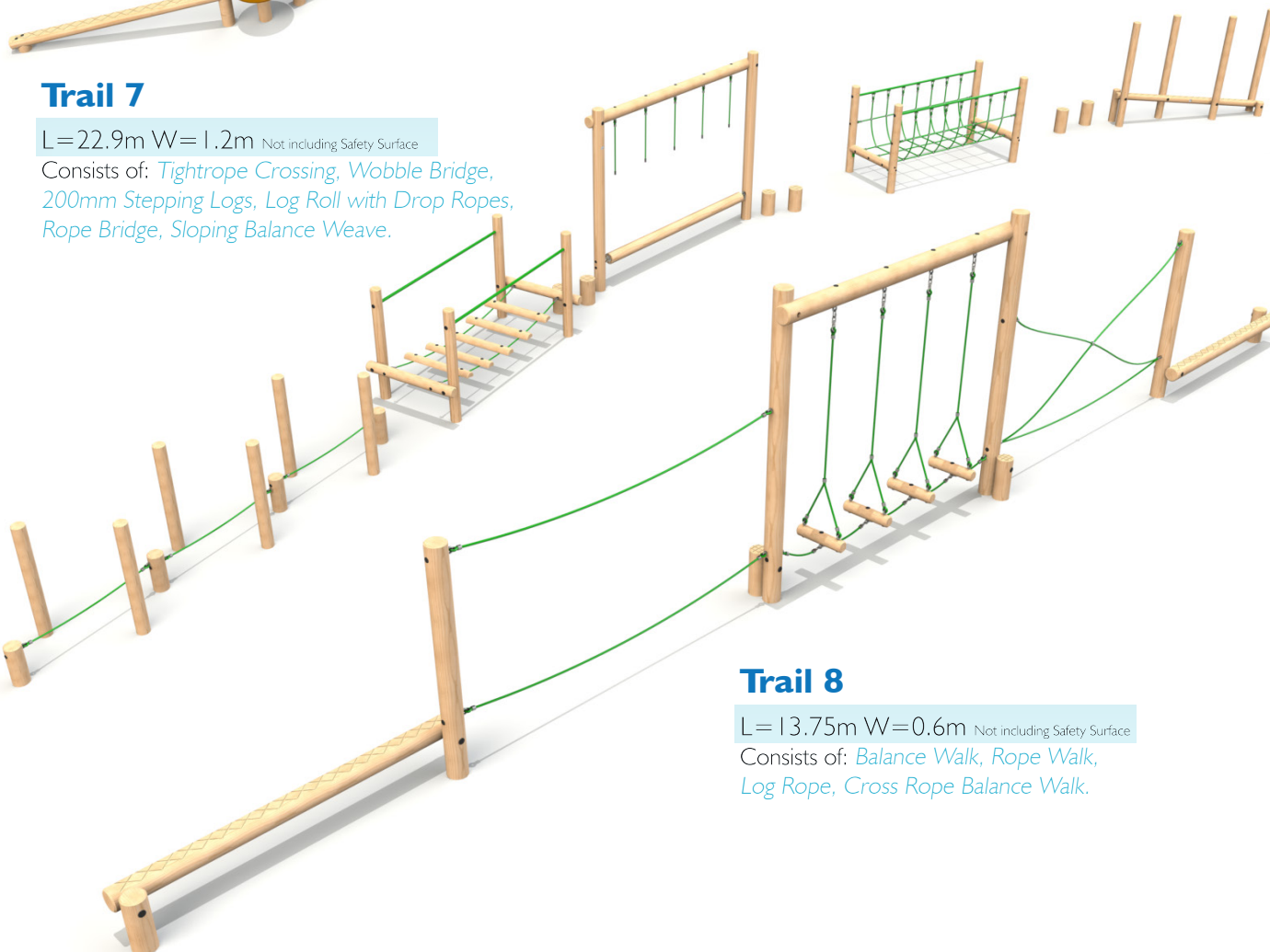

Trail 8

L=13.75m W=0.6m Not including Safety Surface

Consists of: Balance Walk, Rope Walk, Log Rope, Cross Rope Balance Walk.

All trails can be arranged differently to suit your needs!

Trail 9

L=9m W=0.8m Not including Safety Surface

Consists of: *Slalom Rope Walk, Log Snake, Jigsaw Traverse Wall.*

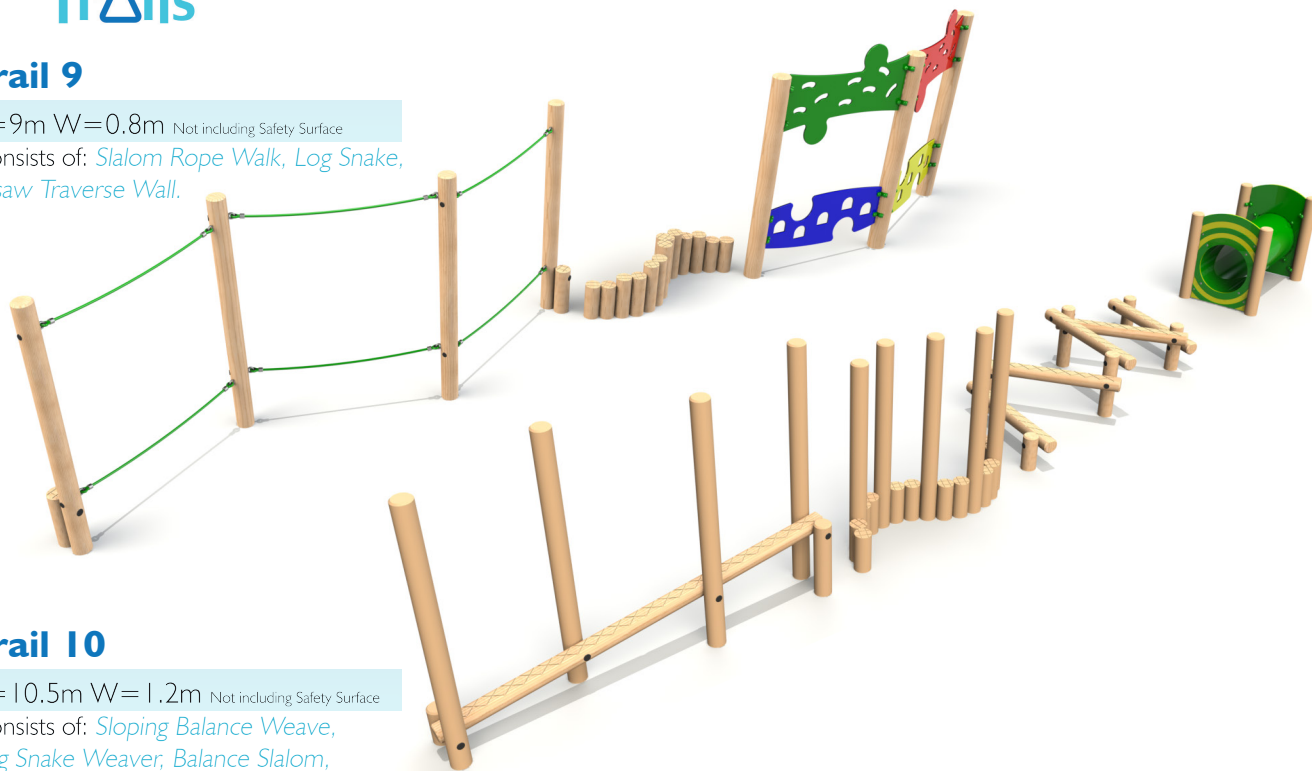

Trail 10

L=10.5m W=1.2m Not including Safety Surface

Consists of: *Sloping Balance Weave, Log Snake Weaver, Balance Slalom, Free Standing Tunnel.*

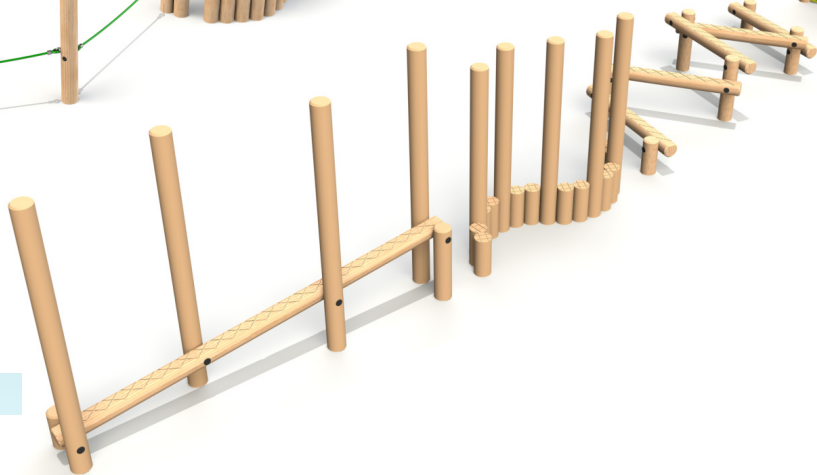

Steel Trail 1

L=12.1m W=1.6m Not including Safety Surface

CONSISTS OF: *Sloped Balance Beam, Drop Rope Traverse, Slalom Rope Walk, Sloping Balance Weave.*



Steel Trail 2

L=14.2m W=0.45m Not including Safety Surface

Consists of: *Sloped Balance Beam, Rope Walk, Log Rope, Cross Rope, Sloped Balance Beam.*

Steel feet

Galvanised steel feet can be fitted on all Timber Trails for a small additional charge. Steel feet offer an alternative to in-ground timbers and can be used in both wet pour and extended for loose fill surfacing.



Steel Trails

Dimensions do not include surfacing
FFH - Free Fall Height

Steel Sloping Balance Beam
L 2400 W 100 H 410mm
FFH 410mm



Steel 3 Bar Balance Beam
L 7200 W 100 H 415mm
FFH 415mm

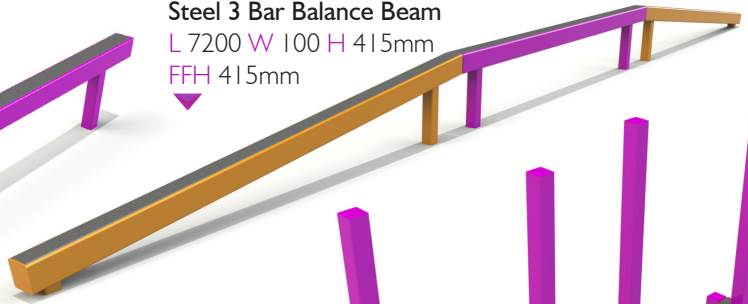

Steel Balance Beam
L 2400 W 100 H 410mm
FFH 410mm



Steel Stilts
L 3600 W 540 H 1800mm
FFH 590mm



Steel Sloping Balance Weave
L 2800 W 300 H 1800mm
FFH 475mm



Steel Slalom Rope Walk
L 3066 W 1587 H 1800mm
FFH 480mm

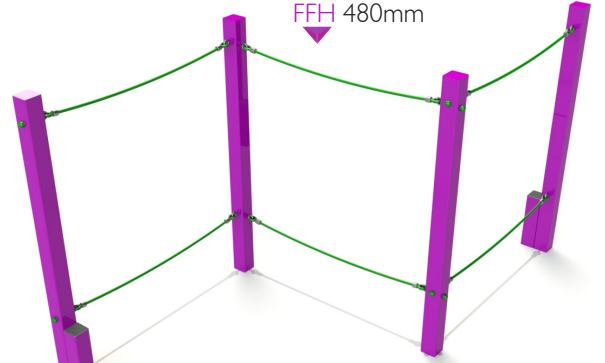

Steel Free Standing Tunnel
L 1300 W 760 H 975mm
FFH 140mm

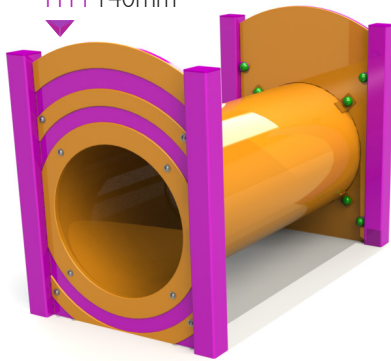

Steel Gate Climber
L 1337 W 100 H 1500mm
FFH 1500mm



Steel Leap Frog
L 8484 W 100 H 1000mm
FFH 1000mm



Steel Cross Rope
L 3200 W 300 H 1800mm
FFH 1000mm

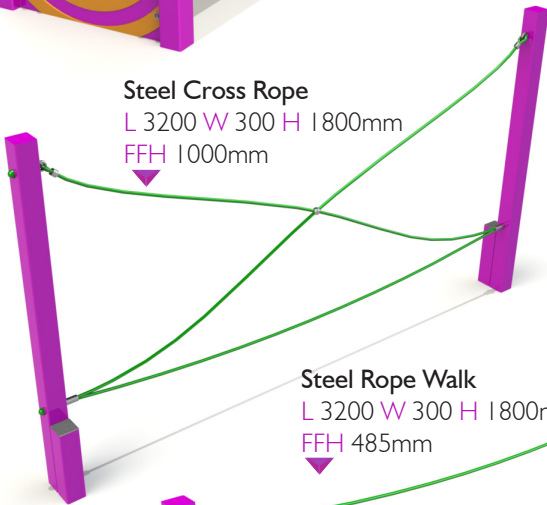

Steel 1.5m Steel Chin Ups
L 3100 W 100 H 1500mm
FFH 1457mm

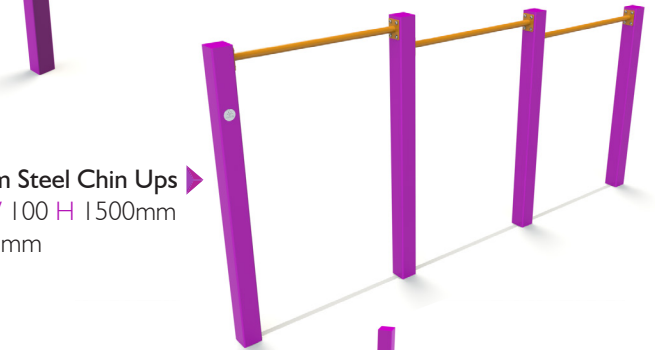

Steel Rope Walk
L 3200 W 300 H 1800mm
FFH 485mm

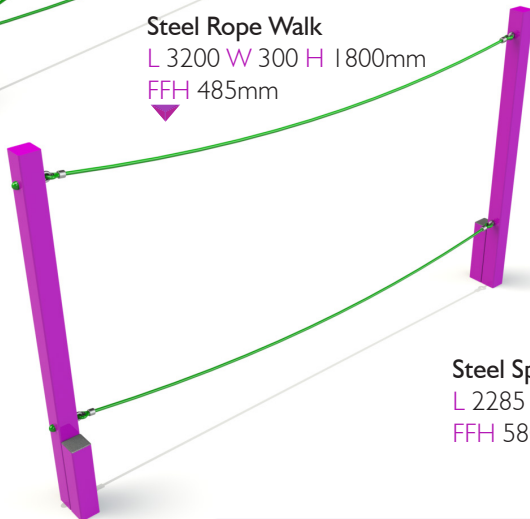

Steel Spider Web Net
L 2285 W 2285 H 1500mm
FFH 580mm

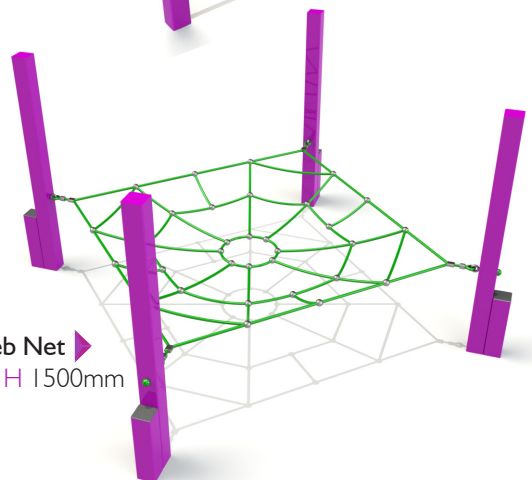

Different paint options available upon request

Steel Trails

Dimensions do not include surfacing
FFH - Free Fall Height

Steel Log Rope
L 2850 W 450 H 2500mm
FFH 461mm

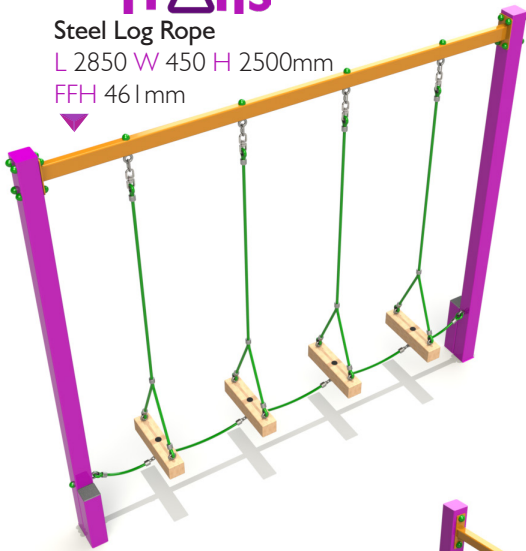

Steel Drop Rope Traverse
L 2850 W 300 H 2500mm
FFH 425mm

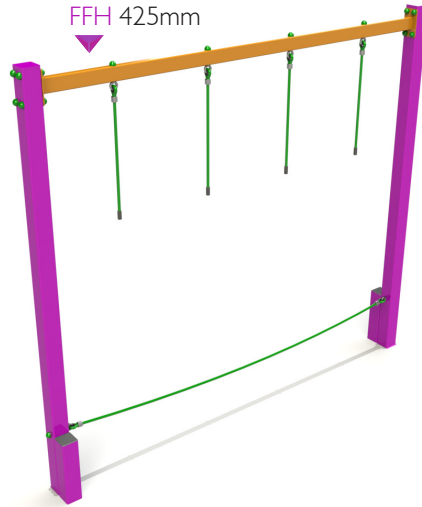

Steel Tarzan Traverse
L 2850 W 300 H 2500mm
FFH 425mm

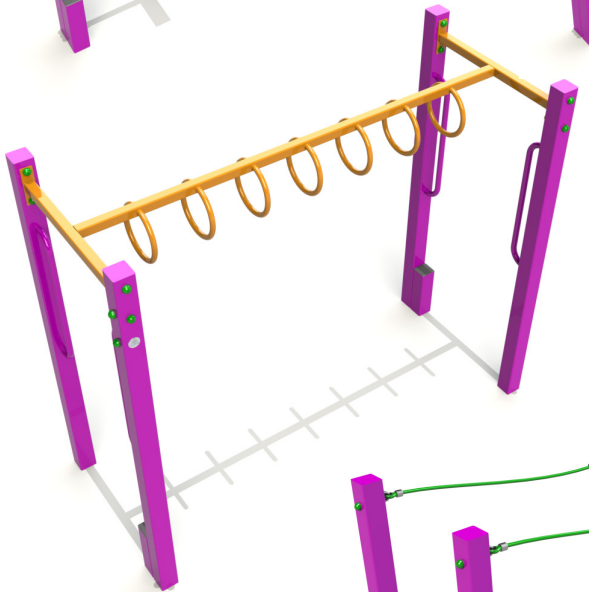
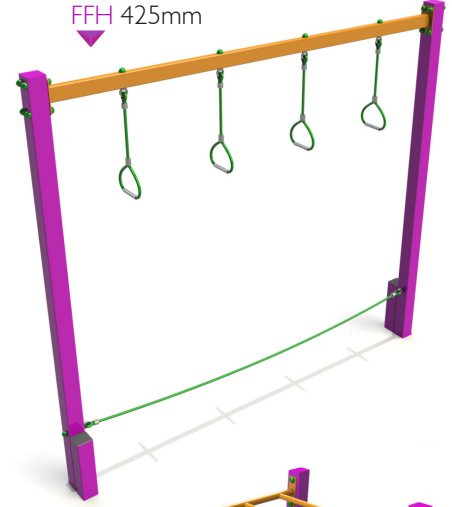

Steel Burma Bridge
L 2900 W 850 H 1460mm
FFH 520mm

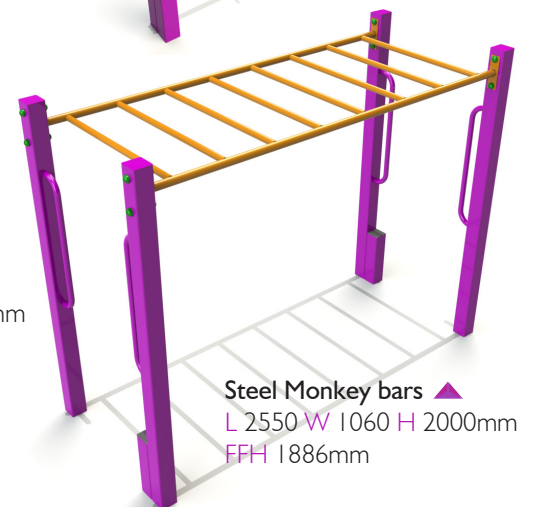

Steel Monkey bars
L 2550 W 1060 H 2000mm
FFH 1886mm

Steel Tarzan Ring Beam
L 2540 W 1065 H 2143mm
FFH 1750mm

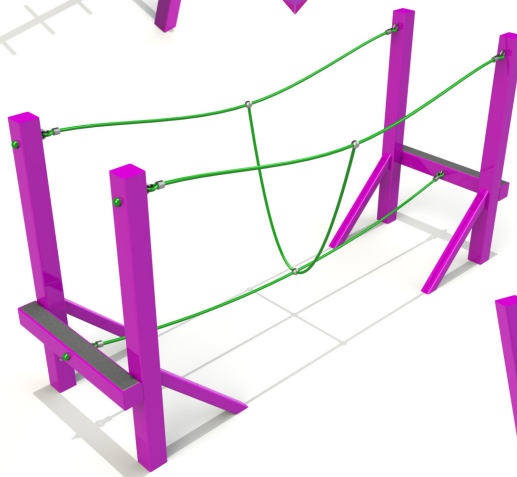

Steel Wobble Bridge
L 2650 W 1100 H 1410mm
FFH 510mm

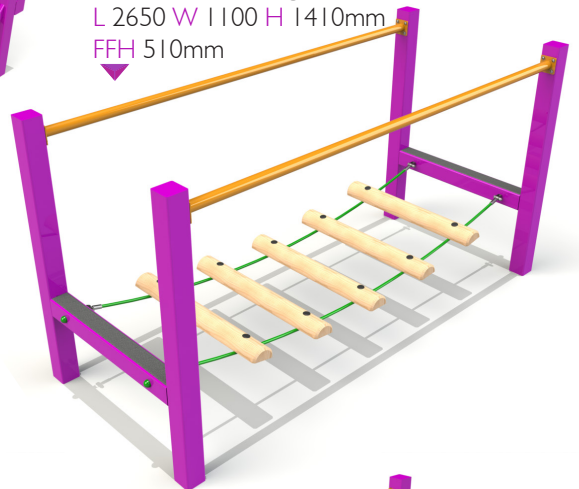

Steel Mini Twist Net
L 2550 W 1100 H 1500mm
FFH 1500mm



Steel Suspension Bridge
L 2150 W 1100 H 1400mm
FFH 510mm

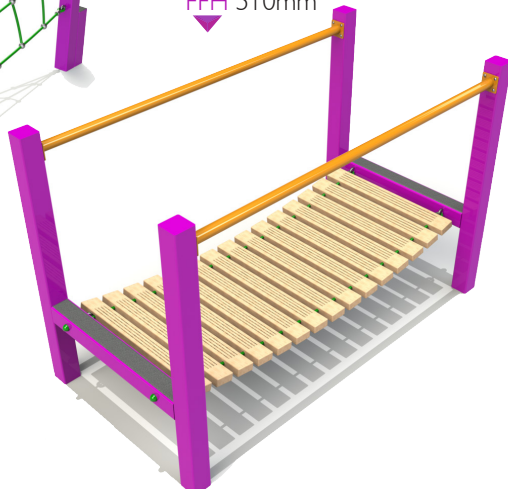

Steel Rope Bridge
L 2600 W 1100 H 1410mm
FFH 1410mm

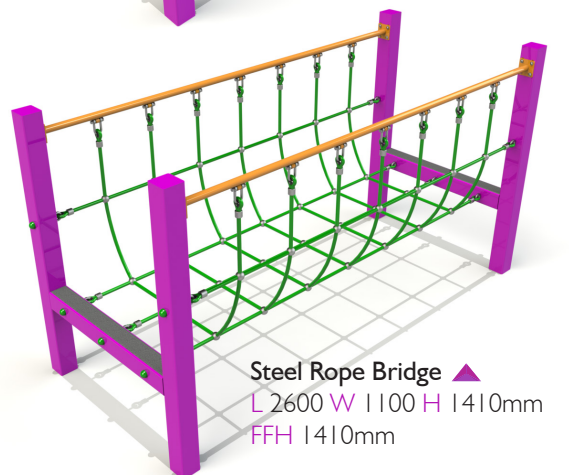

Different paint options available upon request



The ability to offer unrivalled value for money whilst still ensuring exceptional quality and longevity is key. The Adventure Trails range accommodates all ages, budgets and play scheme sizes. Our uncompromising approach to safety during the design and manufacturing process is paramount.

With this in mind all the Timber Trail items have been independently certified by the Play Inspection Company to meet the demands BS EN 1176.

In order to ensure the highest level of accuracy, all units are produced on a custom made, state of the art, 6 Axis CNC machine. This technology allows us to offer unparalleled accuracy in the field of play timber production.

Tel: 01536 601950 / 07539629573 rpm@reidsplayground.co.uk www.reidsplaygroundmaintenance.co.uk

Reids Playground Maintenance Ltd, The Stone Yard, Furnace Ln, Finedon, Wellingborough NN9 5NY